

Castel

Airco

BY CASTEL ENGINEERING

The accessories for an easy and complete professional installation

Castel Engineering is a Belgian company specialized in the extrusion and injection moulding of plastic parts mainly for the HVAC-R industries. Founded in 1987 as a small company, it has been growing ever since to become a European leader and a standard reference for quality.

The wide variety of product ranges provides high-quality components for clean- and coldroom, panel and refrigerated door manufacturers as well as for the installation of air conditioners.

With ideal locations for logistics, Castel Engineering Group of companies is proud to serve over 70 countries around the world. Castel Engineering Polska Sp zoo, located in Poland, takes care of the Eastern European markets. Rodigas srl, Italian manufacturer and a European leader in the production of brackets for air conditioning installations and many other accessories also for solar photovoltaic applications, joined our group in 2019.

Disclaimer:

V.2022-I-30-ENG

Hereinafter the terms "we", "our", "ourselves", "us" refer to Castel Engineering srl and Affiliates or sister companies. The products mentioned in this document are meant to be purchased, installed, periodically checked and maintained only by professionals specialised in Heating, in Ventilation, in Air-Conditioning or in Refrigeration (HVAC-R) that are supposed to have sufficient professional know-how to select the right product according to their intended use and their installation. Any product disposal is at the sole and entire responsibility and expense of the installer, and should be done in respect with all regulations in application at the installation site. We advise our customers to check whether the products they choose are appropriate for their intended use as their application, use, execution, installation and maintenance are carried out of our control.

Those who in any way handle our products are sole responsible for determining (a) the suitability of the products for their intended use, (b) the appropriate manner of processing and maintaining the product to ensure safety and quality and (c) chemical, physical and health effects related to those activities, (d) to inform themselves in order to be able to decide if specific data are necessary prior to their installation in respect to climatic and environment conditions, norms and regulations in application at the locations of storage and installation, (e) to control if the supporting structure on which the product(s) will be installed is resistant enough for the intended use, (f) to use appropriate tools and fixing materials for the installation and for the maintenance. Customers, installers and third parties are sole responsible for damages or failures in performance resulting from misuse, abuse, neglect or improper handling, transporting or storage. Until installed our products must remain in their original packaging, sheltered from climatic conditions. Our warranty is exclusively limited to the supply of a product of constant quality according to our standards. If our product liability is confirmed, the limited warranty will only be such as, at our sole discretion, to make available equivalent or similar replacement goods in conformity to our standards of quality to replace the goods considered faulty.

Notwithstanding the care we take to conceive and to manufacture our products, a little difference in the color can be noticed between batches of different production runs.

This is inherent to our production processes and technological limits of our equipment. When mentioned, dimensions are rounded off and are not meant for manufacturing purposes. Tolerances apply. Unless specifically mentioned in the document, all data, whenever a notion of safety factor or safety parameter to be taken into account may implied or requested, is expressed without.

Technical datasheets are available on written request. We reserve us the right to modify all data contained in this document without prior notice. We recommend you contact us before quoting your customers.

The information in this document has been carefully checked and is believed to be accurate. However no responsibility is assumed nor for translating nor typographical nor for proofreading errors neither omissions. Due to the evolution of standards, materials, equipment or other reasons, the characteristics indicated by text or representations or illustrations or drawings and depicted products in this document are not binding for us until our services have specifically confirmed them.

Unless otherwise specified, in all our communications, pricelists, quotations, order confirmations and other commercial documents, all our prices are always expressed without taxes.

Purchasing from Castel Engineering srl or its Affiliates is submitted to its General Conditions of Sale.

They can be found on the website <http://www.castel-engineering.com>

or can be obtained by a simple written request to info@castel-engineering.com

All pictures and drawings in this literature are for illustration purposes only. Data may change without prior notice and are subject to tolerances. Castel Engineering Sprl., its Affiliates and its Distributors cannot be held liable for typographical errors, layout errors or technical misinformation contained herein.

This catalogue cancels and replaces all former versions. It is the sole responsibility of the customers to request to obtain the most recent version in force of this catalogue.

Copyright © 2022 - Castel Engineering srl - Belgium - www.castel-engineering.com - All rights reserved, including right to translate.

70
COUNTRIES
AROUND
THE WORLD



Castel Engineering Belgium



Castel Engineering Polska Sp. z o.o.



Rodigas Srl





SpeediDuct®



Roof Inlet + Flexy Tube



ClimClick® + mini FrameFoot®



Rubberblocks

06

ABOUT CASTEL

12

CASTEL ENGINEERING DUCTS OVERVIEW

06 The company

Our values

Production

Engineering solutions

Manufacturing quality

Fully in-house

Respect for the environment

Protect your linesets

12 SpeediDuct®

Installation instructions
SpeediDuct®
Flexy Kit
Parts

22 OptimalDuct

Installation instructions
OptimalDuct
Flexy Kit
Parts

30 ClimClick®

Installation instructions
ClimClick®
Flexy Kit
Parts

38 CastelPlus®

Floor Supports -
Mountblocks
Anti-vibration Pads
Rubberblocks
Roof Inlets
Easybend
Wall Sleeve - Split Covers
Roof Bracket
Vibration Dampers
Isolator Switches
Flexible connection hoses
Through the wall kit

52 Rapid-O®

Plug & Play Copper
Refrigeration Fittings

56 AcquaRing®

Installation Instructions
Rigid Drain Pipes
Accessories - Parts
Pre-installation Boxes
Condensation Trays

68 FrameFoot®

FF4
FF2 Extension Module
Mini FrameFoot®
Heat Pump support
VRF Support

Castel Engineering

Our values

As a manufacturer Castel Engineering is aware that modern economy requires constant and swift adaptation, while diversification of the offer will ensure a growing market share.



New rubber production equipment



Products of very high quality

Though the tendency is towards a never-ending downwards spiral of cheaper products, we commit ourselves to still manufacture products of very high quality. Thanks to full control of our production processes and tool conceptions, we have been able to keep our commitments while remaining the most competitive.



Stock and transport

Keeping a well-filled stock is another service we provide to our customers. Our H.Q. on-site storage has a capacity of 26.000m². Offering fast and competitive transport solutions is also part of our service.

A personal approach

We consider it our duty to support our customers with their requests. We are keen on sharing our expertise in order to allow them to opt for the best suitable solution for their projects. Communication is crucial. We take care of every customer with an individual and personal approach. Our multilingual sales team will follow up your requests step by step, so as to understand your needs, advise the selection of the right products, send a quotation and ensure that your order is delivered at your warehouse.



Production

We have reached an ever growing consumption of 3.500 ton raw materials to feed the machinery park that Castel Engineering currently houses at its H.Q. to serve and extend our offer and services to the customers.

Our Research and Development department, equipped with rapid 3D prototyping equipment, has the task of ensuring that our products keep up with the evolution of technology. Their other key role is to keep on improving existing products and conceiving new ones, with a reduced ecological footprint, complying with new standards.

Engineering solutions

With over 30 years of experience in plastics processing we have been able to gather and increase the essential knowledge to become and remain a European leader.

We continuously improve our products to offer an up-to-date response to the constantly changing markets.

We have accumulated a respected know-how in tool design which helps optimizing manufacturing costs while enabling us to produce high quality at the most competitive prices. Many satisfied customers have also entrusted us with the conception and manufacturing of some of their OEM components.

//
**The accessories for
 an easy and complete
 professional installation**
 //

Manufacturing quality

We can guarantee a high quality of manufacturing thanks to

- > Modern, up-to-date machinery
- > Prime raw materials from renowned industrial suppliers who give us their full support
- > Quality control checks on a regular basis
- > Batch tracing through barcode system.



Fully in-house

The Castel Engineering group has both extrusion and injection moulding production processes as well as rubberblock manufacturing as expertise, which is exceptional in its sector.

Packing is also done "in-house" which allows quality control over the whole process, from raw material processing to products ready packed for dispatch.

Orders are prepared and shipped on a virtually permanent stock availability.

Respect for the environment

We are conscious that natural resources on our planet are limited.

Anxious not to waste them we have i.a. :

- > a recycling program that allows us to recover and reuse as much raw materials as possible (i.a. 80 ton rubber per week)
- > packaging, mainly from recycled origin, carefully selected for its minimum ecological footprint
- > invested in solar panels to provide much of our energy requirement
- > been purchasing green energy to cover the rest of our consumption

high quality
in a trendy look



Protect your linesets

The insulation of linesets is particularly vulnerable to degradation due to climatic conditions and UV radiation. Without proper protection the insulation may crack and crumble, losing its insulation properties.



Energy Saver = Cost Saver

Air conditioner and heat pump equipment do not operate properly when linesets or their insulation get damaged.

This may lead to an increased energy consumption and finally to higher maintenance costs or even require an entire unit replacement before its normal end of life.

Our ducts protect your linesets and, in that sense, contribute to save energy and extend the life of your equipment.

SpeediDuct®

Easy to install, fittings
with screws

Protects the linesets
and the unit

Helps saving energy

Extends the units life cycle

Aesthetic Design

Paintable

UV-Resistant



SpeediDuct®
covers it all,
from the unit
to the wall

SpeediDuct® in 3 different sizes



Depending on installation configurations, ducts' contents may vary.

Product features and benefits

1 man job	Use the SpinFix-clip to keep ducts contents strapped while installing the cover. Easy and Fast !	
Asymmetrical : Easy when installed in corners	Ducts 70 and 105 have an asymmetrical Design. When installed in corners, the smaller duct top side is easy to clip onto the base channel.	
Up to 150mm wide	Duct size 150 is the widest of its kind, ideal for multi-split or heat pump installations. It has 2 SpinFix rails : 1 in the top and 1 in the base channel	
Rigid installation	Top-Bottom fittings assembled with stainless steel screws ensure a rigid installation	
Large selection of fittings	Not all installations are the same. Some require specific fittings like the soffit inlet, the long flat bend with its larger bending radius for linesets.	

SpeediDuct®



- > Made of rigid, shockproof, UV-stabilized fire resistant PVC
- > High-quality (usable from -20°C / -4°F to +60°C / 140°F in a static position)
- > Thanks to the inside fixation rail, the SpinFix allows you to use cable ties to strap and keep the linesets in place, contributing to the duct rigidity.

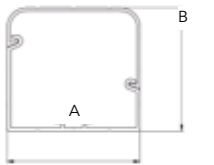

	70	105	150
Model	SP.D.70	SP.D.105	SP.D.150*
Part Nr CW903	0504.00001.013	0504.00101.013	0504.00201.014
Part Nr CI902	0504.00001.011	0504.00101.011	0504.00201.012
A = Width	70mm (2,76")	105mm (4,13")	150mm (5,90")
B = Height	65mm (2,5")	75mm (3")	80mm (3,15")
L=Length	2 M (6,5 ft)	2 M (6,5 ft)	2 M (6,5 ft)
Packing	10 pcs (20 M)	6 pcs (12 M)	5 pcs (10 M)
Pallet	500M (250 pcs / 25 BOX)	300M (150 pcs / 25 BOX)	250M (125 pcs / 25 BOX)

Spinfix



Model	SFIX1000	SpinFix + Cable Ties SFIXCT100
Part Nr	0508.00008.000	0508.00008.023
Packing	1000 pcs (Without Cable Tie)	10 sets (1set = 100x SpinFix & Cable Tie)

Flexy Kit

Protects your linesets from the condenser unit to the wall. Saves time when connecting 2 ducts in special architectural configurations

- CW903 pure white**
- CI902 ivory

- > 1x Flexible hose
- > 2x Flex connector
- > 1x Flex-end
- > 1x Stainless steel clamp



1 kit / box

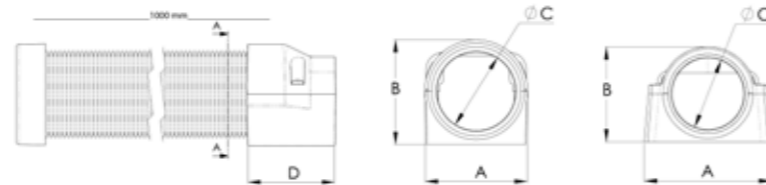

70

105

Model	SP.FLEX.70	SP.FLEX.105
Part Nr CW903	0504.00021.075	0504.000121.075
Part Nr CI902	0504.00021.072	0504.000121.072
A x B	80 x 80 mm (3,15 x 3,15")	140 x 110 mm (5,51 x 4,33")
C (Inside ø)	60 mm (2,36")	80 mm (3,15")
D	70mm (2,76")	80 x 115 mm (3,15 x 4,53")
Hose length	1 M (3,28 ft)	1 M (3,28 ft)
Packing	1 set	1 set
Pallet	80 sets	80 sets



** Flexible Hose and end cap are always in Ivory (CI902) colour. SEE ALSO OUR OTHER FLEXIBLE SOLUTIONS in section "Castel Plus (R)"



Copyright © 2022 Castel Engineering srl - CAT.AIRCO22v1-1X-F00.000000.020

Wall Cover

- CW903 pure white
- CI902 ivory

> As wall inlet or outlet



70

105

150

Model	SP.WC.70	SP.WC.105	SP.WC.150*
Part Nr CW903	0504.00009.016	0504.00109.016	0504.00209.016
Part Nr CI902	0504.00009.015	0504.00109.015	0504.00209.015
Packing	10 pcs	10 pcs	10 pcs
Pallet	480 pcs	320 pcs	320 pcs

Connection Piece

- CW903 pure white (1)
- CI902 ivory (2)



70

105

150

Model	SP.CP.70	SP.CP.105	SP.CP.150*
Part Nr CW903	0504.00012.016	0504.00112.016	0504.00212.016
Part Nr CI902	0504.00012.015	0504.00112.015	0504.00212.015
Packing	10 pcs	10 pcs	10 pcs
Pallet	840 pcs (1) / 1680 pcs (2)	1680 pcs	840 pcs (1) / 1680 pcs (2)

Soffit Inlet

- CW903 pure white
- CI902 ivory

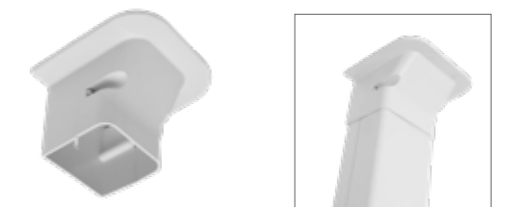

70

105

Model	SP.SI.70	SP.SI.105
Part Nr CW903	0504.00017.016	0504.00117.016
Part Nr CI902	0504.00017.015	0504.00117.015
Packing	10 pcs	10 pcs
Pallet	640 pcs	480 pcs

* For SPD150mm (5.9") FITTINGS in CW903 pure white : contact us for availability, MOQ and OIM
Please respect the recommendations of paint manufacturers for painting PVC, ASA, PE and PP plastics. We recommend painting in bright colours only.

Copyright © 2022 Castel Engineering srl - CAT.AIRCO22v1-1X-F00.000000.020

Flat Rosette

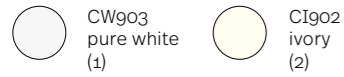

- > A duct can be mounted flush to the vertical wall while the Flat Rosette covers the hole for the linesets to pass through the ceiling.



70

105

150

Model	SP.FR.70	SP.FR.105	SP.FR.150*
Part Nr CW903	0504.00007.016	0504.00107.016	0504.00207.016
Part Nr CI902	0504.00007.015	0504.00107.015	0504.00207.015
Packing	10 pcs	10 pcs	10 pcs
Pallet	840 pcs	840 pcs (1) / 1680 pcs (2)	840 pcs

Adjustable Flat Bend



- > Adjustable between 90° and 135°
- > Uneven wall surfaces or specific installations may require SpeediDuct® to be connected at various angles, the adjustable flat bend is the flexible solution for this problem

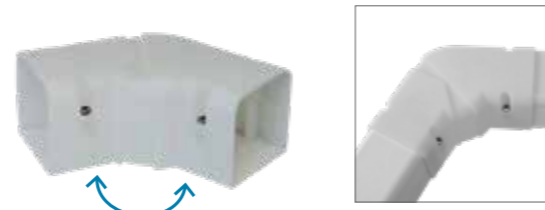

70

105

Model	SP.AFB.70	SP.AFB.105
Part Nr CW903	0504.00016.016	0504.00116.016
Part Nr CI902	0504.00016.015	0504.00116.015
Packing	10 pcs	10 pcs
Pallet	640 pcs	320 pcs

90° Flat Bend



70

105

150

Model	SP.FB.70	SP.FB.105	SP.FB.150*
Part Nr CW903	0504.00005.016	0504.00105.016	0504.00205.016
Part Nr CI902	0504.00005.015	0504.00105.015	0504.00205.015
Packing	10 pcs	10 pcs	10 pcs
Pallet	640 pcs	640 pcs	320 pcs

* For SPD150mm (5.9") FITTINGS in CW903 pure white : contact us for availability, MOQ and OIM
Please respect the recommendations of paint manufacturers for painting PVC, ASA, PE and PP plastics. We recommend painting in bright colours only.

Copyright © 2022 Castel Engineering srl - CAT.AIRCO22v1-IX-F00.00000.020

45° Flat Bend

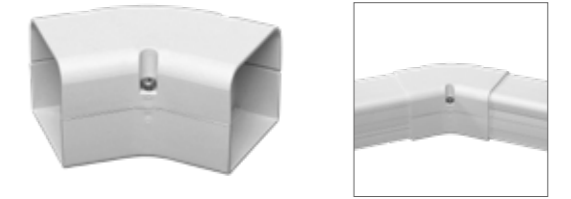

70

105

150

Model	SP.FB45.70	SP.FB45.105	SP.FB45.150*
Part Nr CW903	0504.00004.016	0504.00104.016	0504.00204.016
Part Nr CI902	0504.00004.015	0504.00104.015	0504.00204.015
Packing	10 pcs	10 pcs	10 pcs
Pallet	320 pcs	480 pcs	480 pcs

90° Outside Elbow Bend



- > To place around the outside corner

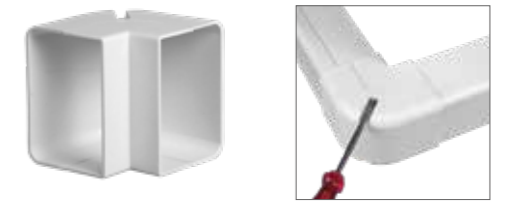

70

105

150

Model	SP.EIN.70	SP.EIN.105	SP.EIN.150*
Part Nr CW903	0504.00003.016	0504.00103.016	0504.00203.016
Part Nr CI902	0504.00003.015	0504.00103.015	0504.00203.015
Packing	10 pcs	10 pcs	10 pcs
Pallet	640 pcs	480 pcs	480 pcs

90° Inside Elbow Bend



- > To place inside the internal corner

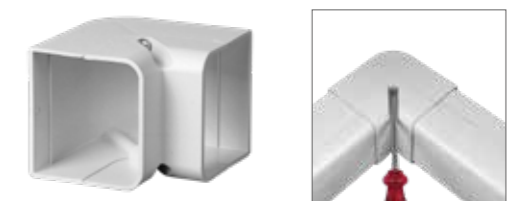

70

105

150

Model	SP.EB.70	SP.EB.105	SP.EB.150*
Part Nr CW903	0504.00002.016	0504.00102.016	0504.00202.016
Part Nr CI902	0504.00002.015	0504.00102.015	0504.00202.015
Packing	10 pcs	10 pcs	10 pcs
Pallet	640 pcs	480 pcs	480 pcs

* For SPD150mm (5.9") FITTINGS in CW903 pure white : contact us for availability, MOQ and OIM
Please respect the recommendations of paint manufacturers for painting PVC, ASA, PE and PP plastics. We recommend painting in bright colours only.

Copyright © 2022 Castel Engineering srl - CAT.AIRCO22v1-IX-F00.00000.020

90° Long Flat Bend

- CW903 pure white
- CI902 ivory

> Thicker insulated linesets may require a bigger bend radius. This part is the best solution to avoid crushing them.



70

105

150

Model	SP.LFB.70	SP.LFB.105	SP.LFB.150*
Part Nr CW903	0504.00008.016	0504.00108.016	0504.00208.016
Part Nr CI902	0504.00008.015	0504.00108.015	0504.00208.015
Packing	10 pcs	10 pcs	10 pcs
Pallet	320 pcs	320 pcs	320 pcs

T-Joint

- CW903 pure white
- CI902 ivory

For Multi-split Systems / Reducer joints are required when combining

- > a duct of 70mm/3" with a duct of 105mm/4"
- > a duct of 105mm/4" with a duct of 150mm/6"

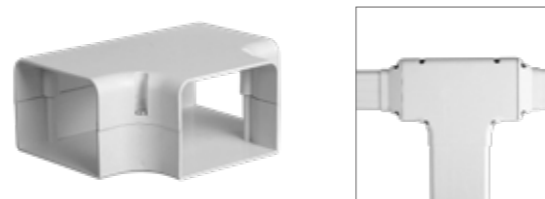

105

150

Model	SPTJ.105	SPTJ.150*
Part Nr CW903	0504.00115.016	0504.00215.016
Part Nr CI902	0504.00115.015	0504.00215.015
Packing	10 pcs	10 pcs
Pallet	480 pcs	320 pcs

Reducer Joint

- CW903 pure white (1)
- CI902 ivory (2)

> To combine with a T-joint



105

150

Model	SP.RJ.70.105	SP.RJ.105.150*
Part Nr CW903	0504.00011.016	0504.00111.073
Part Nr CI902	0504.00011.015	0504.00111.016
Packing	10 pcs	10 pcs
Pallet	840 pcs (1) / 1680 pcs (2)	320 pcs (1) / 640 pcs (2)

* For SPD150mm (5.9") FITTINGS in CW903 pure white : contact us for availability, MOQ and OIM
Please respect the recommendations of paint manufacturers for painting PVC, ASA, PE and PP plastics. We recommend painting in bright colours only.

Duct Cap

- CW903 pure white (1)
- CI902 ivory (2)

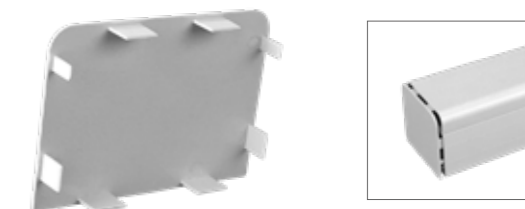

70

105

150

Model	SP.DC.70	SP.DC.105	SP.DC.150*
Part Nr CW903	0504.00013.016	0504.00113.016	0504.00213.016
Part Nr CI902	0504.00013.015	0504.00113.015	0504.00213.015
Packing	10 pcs	10 pcs	10 pcs
Pallet	840 pcs (1) / 1680 pcs (2)	840 pcs (1) / 1680 pcs (2)	840 pcs

Duct End

- CW903 pure white (1)
- CI902 ivory (2)



70

105

150

Model	SP.DE.70	SP.DE.105	SP.DE.150*
Part Nr CW903	0504.00014.016	0504.00114.016	0504.00214.016
Part Nr CI902	0504.00014.015	0504.00114.015	0504.00214.015
Packing	10 pcs	10 pcs	10 pcs
Pallet	320 pcs (1) / 640 pcs (2)	480 pcs	320 pcs

Wall Rosette

- CW903 pure white
- CI902 ivory



70

105

150

Model	SP.WR.70	SP.WR.105	SP.WR.150*
Part Nr CW903	0504.00010.016	0504.00110.016	0504.00210.016
Part Nr CI902	0504.00010.015	0504.00110.015	0504.00210.015
Packing	10 pcs	10 pcs	10 pcs
Pallet	840 pcs	840 pcs	320 pcs

* For SPD150mm (5.9") FITTINGS in CW903 pure white : contact us for availability, MOQ and OIM
Please respect the recommendations of paint manufacturers for painting PVC, ASA, PE and PP plastics. We recommend painting in bright colours only.

OptimalDuct

- Easy & Fast installation
- Protects the linesets and the unit
- Saves energy
- Extends the units life cycle
- Aesthetic Design
- Paintable
- UV-Resistant



the optimal way to
protect your installation

OptimalDuct in 4 different sizes



Depending on installation configurations, ducts' contents may vary.

Product features and benefits

1 man job	Use the SpinFix-clip to keep ducts contents strapped while installing the cover. Easy and Fast !	
Protective Film	Dirty hands while installing ? No worries ! Just remove the protective film from the ducts.	
Wide selection of duct sizes	Choose among the 4 different duct sizes available for your professional installation !	
Fast installation	Just click the fittings onto the duct to complete the installation.	

OptimalDuct

CW903 pure white

Black*

See ClimClick offer pg 33



- > In pure white
- > With protective film.
- > Made of rigid PVC, UV-resistant.
- > High quality (usable from -20°C/-4°F to +60°C/140°F in a static position).
- > Thanks to the inside fixation rail, the SpinFix allows you to use cable ties to strap and keep the linesets in place, contributing to the duct rigidity.



Model	ODF.60	ODF.80	ODF.90	ODF.110
Part Nr CW903	0505.00001.017	0505.00101.018	0505.00201.018	0505.00301.019
A = Width	60 mm (2,36")	80 mm (3,15")	90 mm (3,54")	110 mm (4,33")
B = Height	40 mm (1,57")	60 mm (2,36")	65 mm (2,56")	75 mm (2,95")
L=Length	2 M (6,5 ft)	2 M (6,5 ft)	2 M (6,5 ft)	2 M (6,5 ft)
Packing	12 pcs (24M)	8 pcs (16M)	8 pcs (16M)	4 pcs (8M)
Pallet	960 M (480pcs / 40 box)	560 M (280 pcs / 35 box)	400 M (200 pcs / 25 box)	320 M (160 pcs / 40 box)

Spinfix



Model	SFIX1000	SpinFix + Cable Ties SFIXCT100
Part Nr	0508.00008.000	0508.00008.023
Packing	1000 pcs (Without Cable Tie)	10 sets (1set = 100x SpinFix & Cable Tie)

Flexy Kit

Protects your linesets from the external unit to the wall. Saving time when connecting 2 ducts is an art!

 CW903 pure white*

- > 1x Flexible hose
- > 2x Flex connector
- > 1x Flex-end
- > 1x Stainless steel clamp



1 kit / box

	80	110
Model	OD.FLEX.80	OD.FLEX.110
Part Nr CW903	0505.00114.072	0505.00314.072
A x B	100 x 80 mm (3,94 x 3,15")	120 x 90 mm (4,72 x 3,54")
C (Inside ø)	60 mm (2,36")	80 mm (3,15")
D	90 mm (3,54")	110 mm (4,33")
Hose length	1 M (3,28 ft)	1 M (3,28 ft)
Packing	1 set	1 set
Pallet	80 sets	80 sets

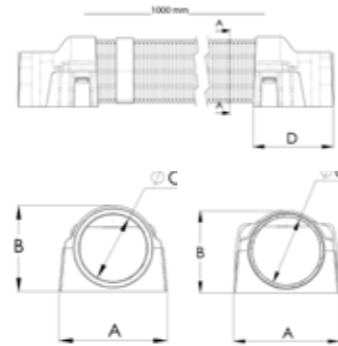

* Flexible Hose and end cap are always in ivory (CI902) colour. SEE ALSO OUR OTHER FLEXIBLE SOLUTIONS in section "Castel Plus"



Adjustable Flat Elbow

 CW903 pure white

- > Adjustable between 90° and 135°
- > Uneven wall surfaces or specific installation require OptimalDuct® to be connected at various angles, the adjustable flat bend is the flexible solution for this problem

	80
Model	ODAFE.80
Part Nr CW903	0505.00115.015
Packing	10 pcs
Pallet	TBC



Copyright © 2022 Castel Engineering srl - CAT.AIRCO22v1-1X-F00.000000.020

Connection Piece

 CW903 pure white

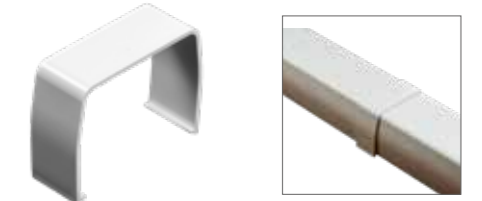

	60	80	90	110
Model	ODC.60	ODC.80	ODC.90	ODC.110*
Part Nr CW903	0505.00003.015	0505.00103.015	0505.00203.015	0505.00303.015
Packing	10 pcs	10 pcs	10 pcs	10 pcs
Pallet	840 pcs	1680 pcs	1680 pcs	1680 pcs

End Cap

 CW903 pure white



	60	80	90	110
Model	ODEC.60	ODEC.80	ODEC.90	ODEC.110
Part Nr CW903	0505.00005.015	0505.00105.015	0505.00205.015	0505.00305.015
Packing	10 pcs	10 pcs	10 pcs	10 pcs
Pallet	840 pcs	1680 pcs	1680 pcs	640 pcs

Wall Cover

 CW903 pure white



	60	80	90	110
Model	ODWC.60	ODWC.80	ODWC.90	ODWC.110*
Part Nr CW903	0505.00008.015	0505.00110.015	0505.00210.015	0505.00310.015
Packing	10 pcs	10 pcs	10 pcs	10 pcs
Pallet	1680 pcs	640 pcs	640 pcs	640 pcs

* new part design

Copyright © 2022 Castel Engineering srl - CAT.AIRCO22v1-1X-F00.000000.020

90° Flat Elbow

 CW903 pure white

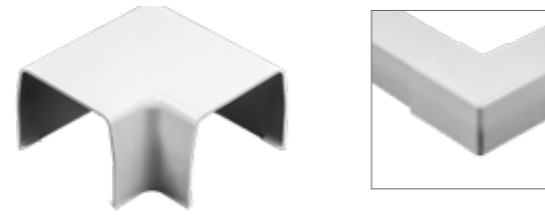

60

80

90

110

Model	ODFE.60	ODFE.80	ODFE.90	ODFE.110
Part Nr CW903	0505.00006.015	0505.00106.015	0505.00206.015	0505.00306.015
Packing	10 pcs	10 pcs	10 pcs	10 pcs
Pallet	840 pcs	640 pcs	640 pcs	640 pcs

90° Elbow Bend Inside

 CW903 pure white

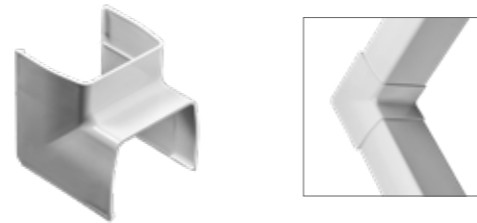

60

80

90

110

Model	ODIC.60	ODIC.80	ODIC.90	ODIC.110
Part Nr CW903	0505.00007.015	0505.00107.015	0505.00207.015	0505.00307.015
Packing	10 pcs	10 pcs	10 pcs	10 pcs
Pallet	840 pcs	1680 pcs	640 pcs	640 pcs

90° Elbow Bend Outside

 CW903 pure white

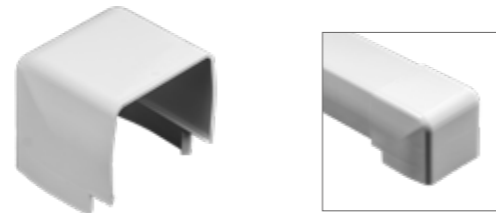

60

80

90

110

Model	ODCO.60	ODCO.80	ODCO.90	ODCO.110
Part Nr CW903	0505.00004.015	0505.00104.015	0505.00204.015	0505.00304.015
Packing	10 pcs	10 pcs	10 pcs	10 pcs
Pallet	840 pcs	1680 pcs	1680 pcs	640 pcs

Copyright © 2022 Castel Engineering srl - CAT.AIRCO22v1-1X-F00.00000.020

Duct Reducer

 CW903 pure white



80

110

110

Model	ODRJ.80.60	ODRJ.110.80	ODRJ.110.90
Part Nr CW903	0505.00108.015	0505.00112.015	0505.00212.015
Packing	10 pcs	10 pcs	10 pcs
Pallet	840 pcs	1680 pcs	840 pcs

Flat Wall Rosette

 CW903 pure white

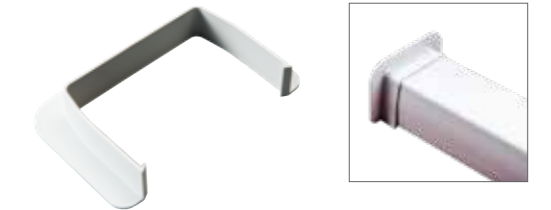

60

80

90

110

Model	ODWR.60	ODWR.80	ODWR.90	ODWR.110*
Part Nr CW903	0505.00009.015	0505.00111.015	0505.00211.015	0505.00311.015
Packing	10 pcs	10 pcs	10 pcs	10 pcs
Pallet	840 pcs	1680 pcs	840 pcs	840 pcs

T-Joint

 CW903 pure white

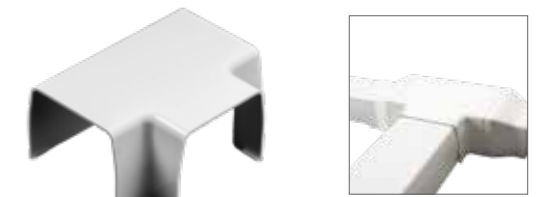

80

90

110

Model	ODTJ.80	ODTJ.90	ODTJ.110
Part Nr CW903	0505.00109.015	0505.00209.015	0505.00309.015
Packing	10 pcs	10 pcs	10 pcs
Pallet	640 pcs	640 pcs	640 pcs

* new part design

Copyright © 2022 Castel Engineering srl - CAT.AIRCO22v1-1X-F00.00000.020

ClimClick®

Easy installation and super fast Click system

Premium fittings upgrade for Optimal Duct sizes 80 and 110

"Click and Done": mount without screws

Paintable

UV-resistant

NEW
ClimClick®
IN BLACK

protect
your linesets
in just
one Click!

A super fast installation thanks to "click-fittings" and SpinFix.

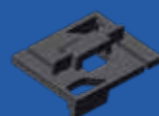

step 1

Fix the bottom parts and the duct to the wall (screws not provided). Easy and fast 'center to center' connection inside the Ducts.



step 2

Place a cable tie in the SpinFix and insert and rotate the SpinFix onto the rail at the bottom of the Duct and ClimClick® fittings.



step 3

Lay the lineset, drain hose inside the duct, strap the cable tie around them without damaging neither deforming them. Cut off any excess of cable tie.



step 4

Cover with the top part of the Duct and remove the protection film.

Duct contents may vary according to installation configurations.



step 5

Install the fitting top (cover). No screws needed = clicking system



optional step*

Paint OptimalDuct® to match the wall colour.

Product features and benefits

<p>Smart for a Fast installation</p>	<p>A) Climclick® fittings guide ducts postioning</p> <p>B) Spinfix holders with "center to center" indications</p>	
<p>Premium fittings for a rigid installation</p>	<p>Finish your installation in just a few seconds !</p> <p>Just click the top parts of the fittings over the ducts.</p>	
<p>Also available in BLACK</p>	<p>Black fittings are individually packed in bags : no finger prints</p>	

ClimClick® fittings are compatible with OptimalDuct sizes 80 and 110



Depending on installation configurations, ducts' contents may vary.

OptimalDuct®

- > With protective film.
- > Made of rigid PVC, UV-resistant.
- > High quality (usable from -20°C/-4°F to +60°C/140°F in a static position).
- > Thanks to the inside fixation rail, the SpinFix allows you to use cable ties to strap and keep the linesets in place, contributing to the duct rigidity.

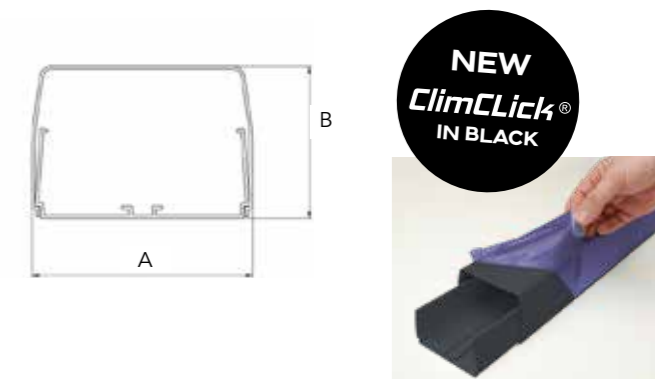

- CW903 pure white
- Black

Model	ODF.80	ODF.110
Part Nr CW903	0505.00101.018	0505.00301.019
Part Nr Black	0505.00101.031	0505.00301.031
A = Width	80 mm (3,15")	110 mm (4,33")
B = Height	60 mm (2,36")	75 mm (2,95")
L=Length	2 M (6,5 ft)	2 M (6,5 ft)
Packing	8 pcs (16M)	4 pcs (8M)
Pallet	560 M (280 pcs / 35 box)	320 M (160 pcs / 40 box)

SpinFix

Model	SFIX1000	SpinFix + Cable Ties SFIXCT100
Part Nr	0508.00008.000	0508.00008.023
Packing	1000 pcs (Without Cable Tie)	10 sets (1set = 100x SpinFix & Cable Tie)

* Please respect the recommendations of paint manufacturers for painting PVC, ASA, PE and PP plastics. We recommend painting in bright colours only.

Wall cover

CW903 pure white **NEW** Black

80

110



Model	ODWC.80	ODWC.110*
Part Nr CW903	0505.00110.015	0505.00310.015
Part Nr Black	0505.00110.031	0505.00310.031
Packing	10 pcs	10 pcs
Pallet	640 pcs	640 pcs

Connection Piece

CW903 pure white **NEW** Black

80

110



Model	CCDC.80	CCDC.110
Part Nr CW903	0505.00580.000	0505.00585.000
Part Nr Black	0505.00580.031	0505.00585.031
Packing	6 pcs	6 pcs
Pallet	1008 pcs	384 pcs

Flat Wall Rosette

CW903 pure white **NEW** Black

80

110



Model	ODWR.80	ODWR.110*
Part Nr CW903	0505.00111.015	0505.00311.015
Part Nr Black	0505.00111.031	0505.00311.031
Packing	10 pcs	10 pcs
Pallet	1680 pcs	840 pcs

90° Flat Elbow

CW903 pure white **NEW** Black

80

110



Model	CCDFE.80	CCDFE.110
Part Nr CW903	0505.00582.000	0505.00587.000
Part Nr Black	0505.00582.031	0505.00587.031
Packing	6 pcs	6 pcs
Pallet	384 pcs	288 pcs

* new part design
Please respect the recommendations of paint manufacturers for painting PVC, ASA, PE and PP plastics. We recommend painting in bright colours only.

Copyright © 2022 Castel Engineering srl - CAT.AIRCO22v1-1X-F00.00000.020

90° Outside Corner

CW903 pure white **NEW** Black

80

110



Model	CCDCO.80	CCDCO.110
Part Nr CW903	0505.00581.000	0505.00586.000
Part Nr Black	0505.00581.031	0505.00586.031
Packing	6 pcs	6 pcs
Pallet	384 pcs	384 pcs

90° Inside Corner

CW903 pure white **NEW** Black

80

110



Model	CCDCI.80	CCDCI.110
Part Nr CW903	0505.00583.000	0505.00588.000
Part Nr Black	0505.00583.031	0505.00588.031
Packing	6 pcs	6 pcs
Pallet	384 pcs	288 pcs

T-Joint

CW903 pure white **NEW** Black

80

110



Model	CCDTJ.80	CCDTJ.110
Part Nr CW903	0505.00584.000	0505.00589.000
Part Nr Black	0505.00584.031	0505.00589.031
Packing	6 pcs	6 pcs
Pallet	384 pcs	192 pcs

Duct Reducer

CW903 pure white **NEW** Black

110



Model	ODRJ.110-80
Part Nr CW903	0505.00112.015
Part Nr Black	0505.00112.031
Packing	10 pcs
Pallet	1680 pcs

Please respect the recommendations of paint manufacturers for painting PVC, ASA, PE and PP plastics. We recommend painting in bright colours only.

Copyright © 2022 Castel Engineering srl - CAT.AIRCO22v1-1X-F00.00000.020

Duct End

● CW903 pure white

80

110



Model	CCDDE.80*	CCDDE.110*
Part Nr CW903	0505.00590.000	0505.00591.000
Packing	6 pcs	6 pcs
Pallet	384 pcs	1008 pcs

*These models are available ON REQUEST
Please respect the recommendations of paint manufacturers for painting PVC, ASA, PE and PP plastics. We recommend painting in bright colours only.

Flexy Kit

Protects your linesets from the condenser unit to the wall.
Saves time when connecting 2 ducts in special architectural configurations

● CW903 pure white**

1 kit / box



- > 1x Flexible hose
- > 2x Flex connector
- > 1x Flex-end
- > 1x Stainless steel clamp

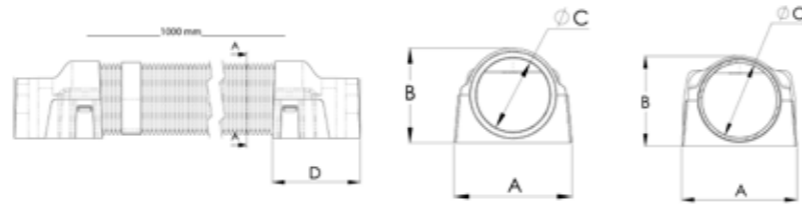

80

110

Model	OD.FLEX.80	OD.FLEX.110
Part Nr CW903	0505.00114.072	0505.00314.072
A x B	100 x 80 mm (3,94 x 3,15")	120 x 90 mm (4,72 x 3,54")
C (Inside ø)	60 mm (2,36")	80 mm (3,15")
D	90 mm (3,54")	110 mm (4,33")
Hose length	1 M (3,28 ft)	1 M (3,28 ft)
Packing	1 set	1 set
Pallet	80 sets	80 sets



** Flexible Hose and end cap are always in ivory (C1902) colour. SEE ALSO OUR OTHER FLEXIBLE SOLUTIONS in section "Castel Plus (R)"

Copyright © 2022 Castel Engineering srl - CAT.AIRC022v1-1X-F00.000000.020

Rodigas®



Rodigas manufactures als Certified Quality products for



www.rodigas.it

Copyright © 2022 Castel Engineering srl - CAT.AIRC022v1-1X-F00.000000.020

Castel Plus®

Roof inlets
Easybend®
Wall sleeve
Split covers
Anti vibration pads
Roof supports



protect the linesets
running the roof
with Flexy Tube
see next pages →

Flexy Cover Kit

The NEW cover kit , also for HEAT PUMPTS
Protects your linesets from the external unit to the wall when no ducts are needed.

 CI902 ivory

- > 1x Wall connection piece
- > 1x Flexible hose
- > 1x Stretchable End cap

Model	FCK.75
Part Nr	0508.00004.000
Diameter ø	80mm (3,15")
Flexible Length	1 M (3,28 ft)
Packing	1 BOX
Pallet	80 BOX



Copyright © 2022 Castel Engineering srl - CAT.AIRCO22v1-1X-F00.000000.020

Flexy Tube

50 M long flexible hose to cover and protect your linesets.
Ideal for long linesets running on roofs

 CI902 ivory



Model	FLEX.60	FLEX.80
Part Nr	0103.00597.000	0103.00596.000
Diameter ø	60mm (3,15")	80mm (2,36")
Flexible Length	50 M (164,04 ft)	50 M (164,04 ft)
Packing	ROLL of 50 M (164,04 ft)	ROLL of 50 M (164,04 ft)
Packing	1 ROLL	1 ROLL
Pallet	6 ROLL (300 M)	5 ROLL (250 M)



Copyright © 2022 Castel Engineering srl - CAT.AIRCO22v1-1X-F00.000000.020

See also our Flexy Kit offers for our ducts

Mountblocks Heavy Duty 100mm

○ White ● Black

- > 360 kg / 794 lbs max. allowable spread-load capacity per item*
- > Condenser unit fixation bolts included
- > Packaged in pairs
- > Suitable for a large range of units (mounting rail feature)
- > High quality (usable from -20°C/-4°F to +60°C/140°F in a static position)
- > UV Resistant



Model	EX.38-350	EX.B38-450	EX.A38-1000
Part Nr CW	0502.00001.007	0502.00002.007	0502.00003.0009
Part Nr Black	0502.00001.008	0502.00002.0008	0502.00003.010
Length	350mm (13,78")	450mm (17,72")	1000mm (39,37")
Width x Height	100x100mm (3,94 x 3,94")	100x100mm (3,94 x 3,94")	100x100mm (3,94 x 3,94")
Packing	1 BOX = 6 x 2 pcs	1 BOX = 6 x 2 pcs	1 BOX = 2 pcs
Pallet	48 BOX (576 pcs)	40 BOX (480 pcs)	95 BOX (490 pcs)

Mountblocks Eco 100mm

○ White ● Black

- > 160 kg / 350 lbs max. allowable spread-load capacity per item*
- > Suitable for a large range of units (mounting rail feature)
- > High quality (usable from -20°C/-4°F to +60°C/140°F in a static position)
- > UV Resistant
- > Condenser unit fixation bolts included



Model	EX.83-350**	EX.C83-450	EX.A83-1000**
Part Nr CW	0502.00007.007	0502.00008.007	0502.00009.009
Part Nr Black	0502.00007.008	0502.00008.008	0502.00010.010
Length	350mm (13,78")	450mm (17,72")	1000mm (39,37")
Width x Height	100x100mm (3,94 x 3,94")	100x100mm (3,94 x 3,94")	100x100mm (3,94 x 3,94")
Packing	1 BOX = 6 x 2 pcs	1 BOX = 6 x 2 pcs	1 BOX = 2 pcs
Pallet	48 BOX (576 pcs)	40 BOX (480 pcs)	95 BOX (490 pcs)

* Based on tests carried out on 450mm model. Check safety parameters that are appropriate for your intended use and contact us if necessary.
** Available only on request

Copyright © 2022 Castel Engineering srl - CAT.AIRCO22v1-1X-F00.000000.020

Mountblock Mini 80mm

○ White

- > 120 kg / 265 lbs max. allowable spread-load capacity per item*
- > Unit fixation bolts included
- > Suitable for a large range of units (mounting rail feature)
- > High-quality (usable from -20°C/-4°F to +60°C/140°F in a static position)

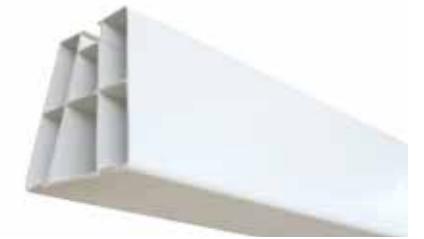

Model	EX.137-350	EX.B137-450	EX.A137-1000
Part Nr CW	0502.00012.007	0502.00013.008	0502.00017.009
Length	350mm (13,78")	450mm (17,72")	1000mm (39,37")
Width x Height	80x80mm (3,15 x 3,15")	80x80mm (3,15 x 3,15")	80x80mm (3,15 x 3,15")
Packing	1 BOX = 6 x 2 pcs	1 BOX = 6 x 2 pcs	1 BOX = 2 pcs
Pallet	63 BOX (756 pcs)	55 BOX (660 pcs)	95 BOX (490 pcs)

Mountblock End Cap

○ White ● Black

- > For Mountblock Heavy Duty (EX.38) and Mountblock Eco (EX.83)

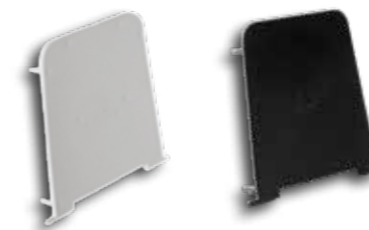

Model	INJ.181
Part Nr CW	0502.00018.036
Part Nr Black	0502.00018.040
Small Packing	1 SET = 4 pcs
Packing	25 SETS (100 pcs)

Mountblock End Cap 'Mini'

○ White

- > For Mountblock Mini (EX.137)



Model	INJ.437
Part Nr CW	0502.00019.036
Small Packing	1 SET = 4 pcs
Packing	25 SETS (100 pcs)

Mountblock Fixation Kit

- > The solution to secure the mountblocks to the ground**



A.12

Model	A.12
Part Nr	0502.00020.000
Set contents	4 fixation plates + 4 anchor bolts
Small Packing	1 SET in a bag
Packing	25 SETS

*Based on tests carried out on 450mm model. Check safety parameters that are appropriate for your intended use and contact us if necessary.

Anti-vibration Pads

- > Performs better than rubber or cork for equivalent size
- > Special composite foam core
- > More efficient than solid rubber vibration damping
- > Ideal for vibration suppression of residential-packaged condensing units



Model	MP-2E	MP-3E	MP-4E	MP-6E
Part Nr	0901.00001.E02	0901.00001.E03	0901.00001.E04	0901.00001.E06
Dimensions (mm)	50 x 50 x 22 mm	75 x 75 x 22 mm	100 x 100 x 22 mm	150 x 150 x 22 mm
Dimensions (inch)	1,97 x 1,97 x 0,87"	2,95 x 2,95 x 0,87"	3,94 x 3,94 x 0,87"	5,90 x 5,90 x 0,87"
Packing	48 pcs	36 pcs	24 pcs	24 pcs
PALLET	8640 pcs	4320 pcs	2400 pcs	864 pcs

Ultralite Pads

- > NO more wasting time with concrete slabs
- > Ready to use concrete slabs
- > Made by Diversitech in the USA
- > Ideal base to mount outdoor units in combination with our rubber feet



Model	UC-2448-3
Part Nr	0502.00001.001
Dimensions (mm)	1200*600*75
Load Capacity	703 Kg
Pallet	15 pcs



Rubber Blocks

- > Universal rail: 42 x 22 mm (for other rail design, contact us)
- > Widths : 180 mm or 130 mm
- > Bolt set is included (not in riser blocks)
- > Blocks strapped per pair (not the risers)



Model	RB25-0/180	RB40-0/180	RB60-0/180	RB100-0/180
Part Nr	0502.02528.000	0502.04028.000	0502.06028.000	0502.01028.000
Length x Width x Height	250 x 180 x 95 mm	400 x 180 x 95 mm	600 x 180 x 95 mm	1000 x 180 x 95 mm
Length x Width x Height	9,84 x 7,09 x 3,74"	15,75 x 7,09 x 3,74"	23,62 x 7,09 x 3,74"	39,37 x 7,09 x 3,74"
Spread Load /pc	120 kg	180 kg	300 kg	350 kg
Packing	1 SET = 2 pcs	1 SET = 2 pcs	1 SET = 2 pcs	1 SET = 2 pcs
Pallet	90 SETS (180 pcs)	60 SETS (120 pcs)	40 SETS (80 pcs)	20 SETS (40 pcs)

Model	RB25-1/130	RB40-1/130	RB60-1/130	RB100-1/130,
Part Nr	0502.12528.000	0502.14028.000	0502.16028.000	0502.11028.000
Length x Width x Height	250 x 130 x 95 mm	400 x 130 x 95 mm	600 x 130 x 95 mm	1000 x 130 x 95 mm
Length x Width x Height	9,84 x 5,12 x 3,74"	15,75 x 5,12 x 3,74"	23,62 x 5,12 x 3,74"	39,37 x 5,12 x 3,74"
Spread Load /pc	120 kg	180 kg	300 kg	350 kg
Packing	1 SET = 2 pcs	1 SET = 2 pcs	1 SET = 2 pcs	1 SET = 2 pcs
Pallet	135 SETS (270 pcs)	90 SETS (180 pcs)	60 SETS (120 pcs)	36 SETS (72 pcs)

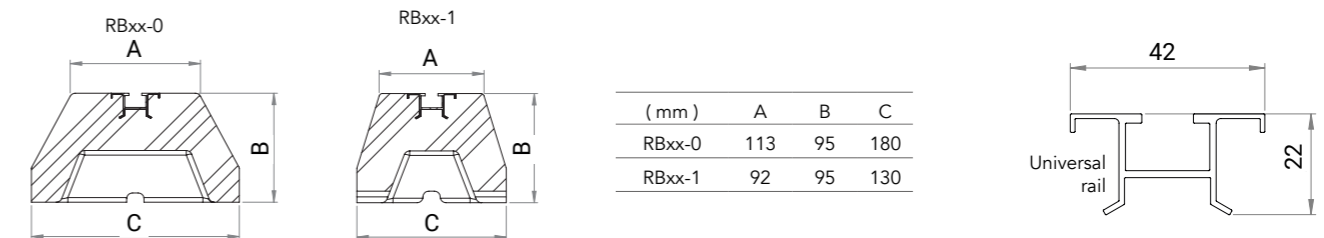

Model	RB-RISER 60-0/180	RB-RISER 100-0/180
Part Nr	0502.26028.000	0502.21028.000
Length x Width x Height	600 x 180 x 105 mm	1000 x 180 x 105 mm
Length x Width x Height	23,62 x 7,09 x 4,13"	39,37 x 7,09 x 4,13"
Spread Load /pc	300 kg	300 kg
Packing	1 pc	1 pc
Pallet	72 pcs	36 pcs

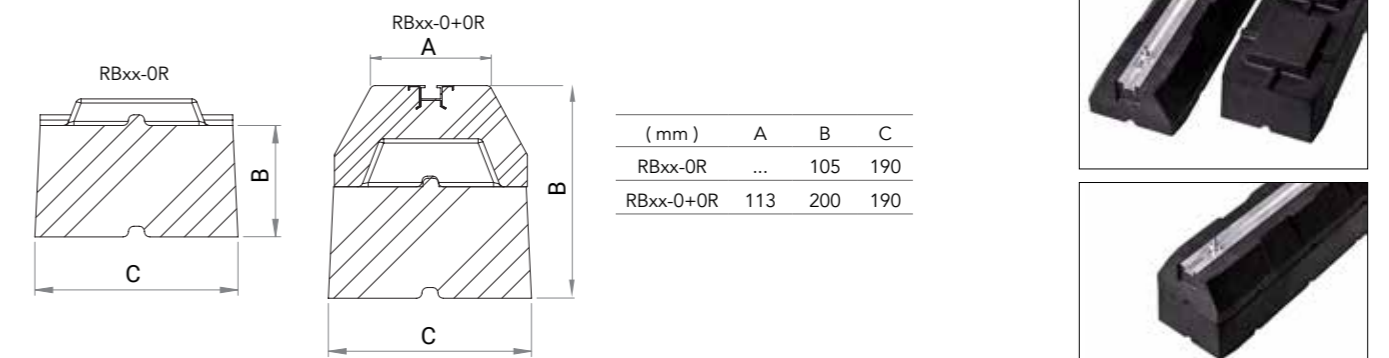

Roof Inlet



White

- > The right solution for rooftop installation requiring linesets to run through the roof.

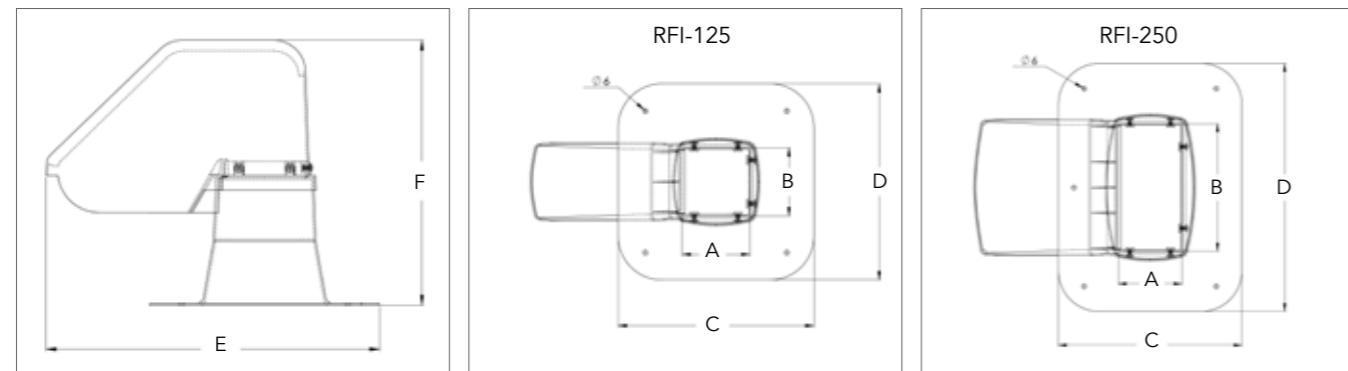

Model	RFI-125	RFI-250
Part Nr	0508.00007.037	0508.00006.037
Colour	white	white
Inside dimensions A x B	125 x 125 mm (4,92 x 4,92")	125 x 250 mm (4,92 x 9,84")
Outside dimensions C x D	360 x 360 mm (14,17 x 14,17")	360 x 490 mm (14,17 x 19,29")
Outside dimensions E x F	520 x 415 mm (20,47 x 16,34")	530 x 420 mm (20,87 x 16,54")
Packing	1 PC	1 PC
Pallet	30 PCS	32 PCS

SEE ALSO OUR OTHER FLEXIBLE ROLLS in previous pages of this section "Castel Plus"

Easybend

Air conditioning lineset bender
No more kinks or leaks when bending your linesets

- > The tool that you need to bend linesets when installing split systems
- > Easiest way to bend dual tubes without damaging their insulation
- > Reusable after cleaning!
- > No need for springs or heavy equipment!
- > Only for linesets made from soft copper



Insert the flexible bender of the right diameter into the copper tube



Bend to required angle.



Retract the flexible bender.



Reusable if kept clean. The benders are ready for the next installation.



No more kinks or leaks when bending your linesets



Scan QR-code and watch the easy-to-use video

Model	EZB				EZB-XT*
Part Nr	0508.00010.000				0508.00011.000
Colour	Red	Green	Yellow	Blue	White
ø (mm) fits tube	4mm for 1/4"	6mm for 3/8"	9mm for 1/2"	12mm for 5/8"	16mm for 3/4"
Length	4 M (13,12 ft)	4 M (13,12 ft)	4 M (13,12 ft)	4 M (13,12 ft)	4 M (13,12 ft)
Small Packing	1 SET contains the 4 different diameters (=colours) / BAG				1 SET per BAG
Packing	15 SETS / BOX				10 SETS / BOX
PALLET	135 SETS				90 SETS

Wall Sleeve



White

- > Protects the insulation of the lineset tubes from damage when passing through the wall
- > The collar covers indoor drill imperfections
- > Cut to adjust to wall thickness, between 100mm / 3,94" and 350mm / 13,78"
- > The hole should be made with a diameter of 64mm / 2,52"

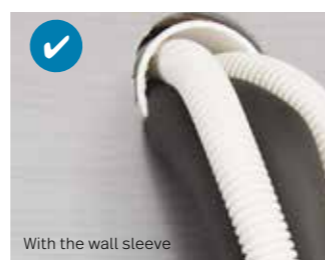
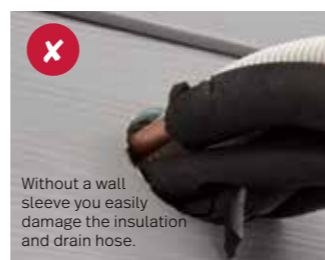
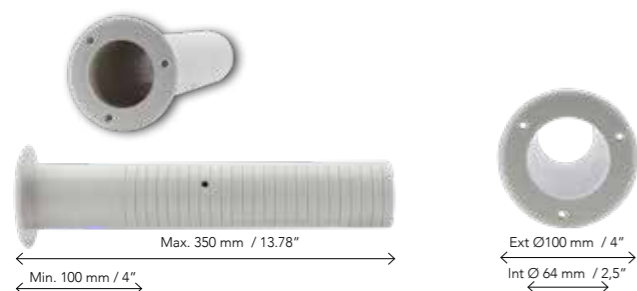

Model	WSLV
Part Nr	0508.00005.028
Colour	white
Packing	10 pcs
PALLET	320 pcs

SPIN Tools

These flaring and swaging tools are designed for most tubing diameters, and they allow you to connect tubes without the need for extra fittings (swage), and preserves the copper malleability (flare) thus preventing cracks and leaks.



Model	F4000	F6000	S4000	S6000
Part Nr	0516.00003.001	0516.00003.002	0516.00003.003	0516.00003.004
Type of SPIN	Flare	Flare	Swage	Swage
Copper sizes	1/4", 3/8", 1/2" 5/8"	1/4", 3/8", 1/2" 5/8", 3/4", 7/8"	1/4", 3/8", 1/2" 5/8"	1/4", 3/8", 1/2" 5/8", 3/4", 7/8"
Packing	1 set	1 set	1 set	1 set

Copyright © 2022 Castel Engineering srl - CAT.AIRCO22v1-1X-F00.00000.020

Copyright © 2022 Castel Engineering srl - CAT.AIRCO22v1-1X-F00.00000.020

Split Covers

- > Protects your installation while minimizing its visual impact
- > Made from treated wood (for outdoor use)
- > Easy & fast installation
- > Inclined roof avoiding water stagnation
- > Can be painted if required
- > Allows air flow
- > Stainless steel screws

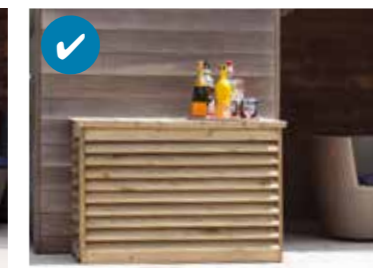
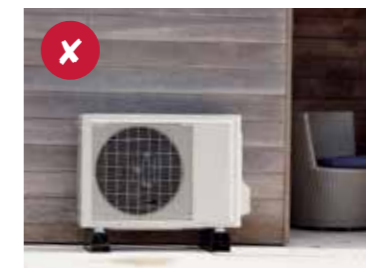
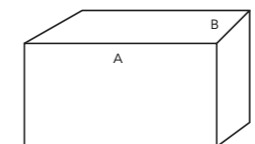

Model	SPC700	SPC950	SP1600
Part Nr	0516.00001.000	0516.00001.001	0516.00001.002
Outside Width (A)	1110mm (43,31")	1160mm (45,67")	1360mm (53,54")
Inside Width (A)	950mm (37,40")	1000mm (39,37")	1200mm (47,22")
Outside Depth (B)	580mm (22,83")	580mm (22,83")	580mm (22,83")
Inside Depth (B)	540mm (21,26")	540mm (21,26")	540mm (21,26")
Outside Height (C)	740mm (29,13")	990mm (38,98")	1580mm (62,20")
Inside Height (C)	720mm (38,35")	970mm (38,19")	1560mm (61,42")
Packing	10 pcs /PAL	10 pcs /PAL	5 pcs /PAL

Roof Bracket

- > Adjustable for sloped roof (min 9°, max 45°)
- > Galvanized steel, powder coated ivory white
- > With vibration damping accessories



Model	MT650
Part Nr	0501.00016.059
Colour	ivory white
Crossbar	800mm (31,50")
Arm Length	520mm (20,47")
Max spread load *capacity	140 kg (308,6 lbs)
Packing	1 PC
PALLET	108 pcs

* Maximum spread load capacity : expressed for spread loading both arms of the bracket

Vibration Dampers

- > Rubber vibration dampers.
- > Manufactured from natural rubber (55° Sh A)
- > External M8-male threaded rod + nuts + washers
- > Foreseen to combine with brackets



Model	BVDCO	BVDCY	FVDCO
part Nr	0503.00002.006	0503.00001.006	0503.00003.006
Part shape	Conical	Cylindrical	Foot
Dimensions (rubber body) mm	30 x 45 x 25 (h)mm	30 x 30 x 30 (h) mm	35 x 50 x 15 (h) mm
Dimensions (rubber body) (")	1,18 x 1,77 x 0,99" (h) inch	1,18 x 1,18 x 1,18" inch	1,38 x 1,97 x 0,59" (h)
Thread	M8	M8	M8
Max spread load*capacity	150 kg (330 lbs) / SET	150 kg (330 lbs) / SET	150 kg (330 lbs) / SET
Packing	4 pcs / SET	4 pcs / SET	4 pcs / SET
Small Packing	50 SETS (200 pcs)	50 SETS (200 pcs)	75 SETS (300 pcs)
PAL	1800 SETS (36 BOX)	2400 SETS (48 BOX)	1800 SETS (24 BOX)

Isolator Switches

Our insulated 3 and 4 pole rotary enclosed isolators are CE marked and suitable for disconnecting the power supply to outdoor air source heat pump units. They are waterproof to IP65 and easy to install. They have a lockable off position and interlocking cover which can be removed only in the off position. Earth and neutral terminals included and M20/25 knockouts up to 63A. Supplied with 2x glands



Model	4P-20A-S	4P-32A-S	4P-40A	4P-63A
part Nr	0516.00002.003	0516.00002.004	0516.00002.005	0516.00002.006
Poles/Ampère	4P-20A	4P-32A	4P-40A	4P-63A
Dimensions (mm)	125 x 100	125 x 100	175 x 114	175 x 114
Packing	1 set with 2x glands	1 set with 2x glands	1 set with 2x glands	1 set with 2x glands

Flexible connection hoses

- > Stainless steel braided hose
- > Pre-insulated with 19mm thick PVC coating
- > 1" and 1-1/4" male or female BSP thread fitting available
- > 28mm / 32mm compression fitting
- > Additional 80mm of insulation to cover the connectors



Model	FH-500-28-F	FH-750-28-F	FH-750-28-1-1/4F	FH-300-28-F-ELBOW
part Nr	0508.00003.000	0508.00003.001	0508.00003.002	0508.00003.003
Length hose (mm)	500	750	750	300 w/o elbows
Connections	1" - 28mm Female	1" - 28mm Female	1 1/4" - 28mm Female	1" - 28mm Female
Packing	(2x lengths of hoses + insulation)	(2x lengths of hoses + insulation)	(2x lengths of hoses + insulation)	(2x lengths of hoses and 2 pre-slit elbows + insulation)

Through the wall kit



- > Avoids heat loss and improves efficiency of the installed air source heat pump
- > 19mm thick PVC coating
- > Suitable for both 22mm and 28mm pipe work
- > All-in one kit



Model	TW-KIT
part Nr	0508.00004.001
Length (mm)	300 w/o elbows
Packing	1 kit (2x lengths of 300mm + 2x pre-slit elbows)

Plug & Play Copper Refrigeration Fittings

- > Easiest and Fastest way to connect copper refrigeration pipes
- > Made from Brass
- > No more flares
- > No more expensive tools
- > UL certified
- > Hard and Soft copper
- > R134A, R404A, R407A, R500, R22, R410A, R32, R407C, R290, R600A

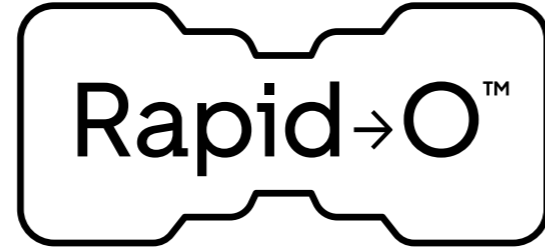

Socket



Model	RPDO-SOCKET-1:4	RPDO-SOCKET-3:8	RPDO-SOCKET-1:2	RPDO-SOCKET-5:8
Part Nr	0512.00003.001	0512.00003.002	0512.00003.003	0512.00003.004
Packing	60 pcs (5 x 12)	60 pcs (5 x 12)	40 pcs (5 x 8)	40 pcs (5 x 8)
Size	1/4"	3/8"	1/2"	5/8"
Max Design Pressure (Bar)	60	60	45	45

Connection Piece



Model	RPDO-CON-1:4	RPDO-CON-3:8	RPDO-CON-1:2	RPDO-CON-5:8
Part Nr	0512.00001.001	0512.00001.002	0512.00001.003	0512.00001.004
Packing	60 pcs (5 x 12)	60 pcs (5 x 12)	40 pcs (5 x 8)	40 pcs (5 x 8)
Size	1/4"	3/8"	1/2"	5/8"
Max Design Pressure (Bar)	60	60	60	60

*Follow the instructions!

Copyright © 2022 Castel Engineering srl - CAT.AIRCO22v1-1X-F00.00000.020

Copyright © 2022 Castel Engineering srl - CAT.AIRCO22v1-1X-F00.00000.020

90° Elbow



Model	RPDO-ELB90 1:4	RPDO-ELB90 3:8	RPDO-ELB90 1:2	RPDO-ELB90 5:8
Part Nr	0512.00002.001	0512.00002.002	0512.00002.003	0512.00002.004
Packing	60 pcs (5 x 12)	60 pcs (5 x 12)	40 pcs (5 x 8)	40 pcs (5 x 8)
Size	1/4"	3/8"	1/2"	5/8"
Max Design Pressure (Bar)	60	60	60	60

Release Tool



Model	RPDO-RL-1:4	RPDO-RL-3:8	RPDO-RL-1:2	RPDO-RL-5:8
Part Nr	0512.00004.001	0512.00004.002	0512.00004.003	0512.00004.004
Packing	40 pcs (5 x 8)	40 pcs (5 x 8)	40 pcs (5 x 8)	40 pcs (5 x 8)
Size	1/4"	3/8"	1/2"	5/8"

*Follow the instructions!

AcquaRing®

- No glue needed
- Saves installation time
- Connects rigid pipes with hoses
- Easy to (re)adjust
- Convenient connecting



quick and easy
products for condensate
water removal

AcquaRing® system

- > No glue = **no waiting time** = fast installation
- > No glue = **(re)adjustable and extendable**
- > With **pre-mounted O-ring**
- > **Pre-lubricated for easy connection**

**no
glue!**



step 1

Cut



step 2

Chamfer and deburr



step 3

Pre-mounted O-ring and pre-lubricated



step 4

Connect



Scan QR-code and watch the easy-to-use video

Designed for use only for air conditioning condensation water without any pressure

Rigid Drain Pipes */**

○ White

- > Made of rigid, self-extinguishing PVC
- > No glue needed, fast installation
- > Chamfer and deburr before inserting into a fitting
- > We recommend the use of non-aggressive installation grease
- > Designed for use only for air conditioning condensation water without any pressure

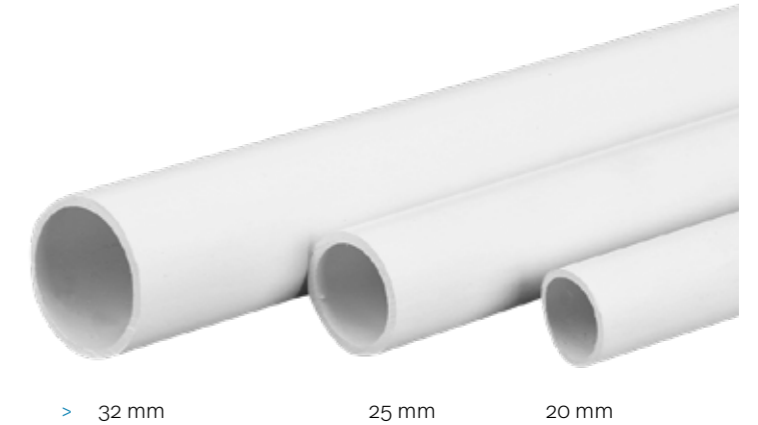

> 32 mm 25 mm 20 mm



NO GLUE NEEDED

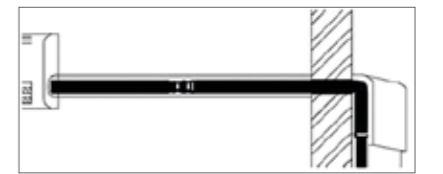
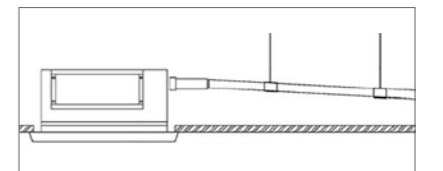

Model	RDP.20	RDP.25	RDP.32
Part Nr	0513.00001.021	0513.00101.021	0513.00201.021
Colour	white	white	white
L=Length	2 M	2 M	2 M
External diameter	20 mm	25mm	32mm
Internal Diameter	18mm	22,5mm	29mm
Packing	100M (50 pcs)	60M (30 pcs)	40M (20 pcs)
PALLET	4000M (2000 pcs)	2400M (1200 pcs)	1600M (800 pcs)

* Pre-mounted and pre-lubricated O-rings : CHAMFER and DEBURR the pipe before inserting it in fittings to avoid damage to the O-rings !
** To be used only for the outlet of air conditioning condensation water (without pressure)

RDP 45° Connection*/**

○ White



NEW
IN BLACK
20mm

Model	RDP20-C45	RDP25-C45	RDP32-C45
part Nr	0513.00002.022	0513.00102.022	0513.00202.022
Colour	white	white	white
Packing	240 pcs (12 x 20)	200 pcs (10 x 20)	100 pcs (5 x 20)
PALLET	7680 pcs (32 BOX)	6400 pcs (32 BOX)	3200 pcs (32 BOX)

RDP 90° Connection*/**

○ White



NEW
IN BLACK
20mm

Model	RDP20-C90	RDP25-C90	RDP32-C90
Part Nr	0513.00003.022	0513.00103.022	0513.00203.022
Colour	white	white	white
Packing	240 pcs (12 x 20)	140 pcs (7 x 20)	100 pcs (5 x 20)
PALLET	7680 pcs (32 BOX)	4480 pcs (32 BOX)	3200 pcs (32 BOX)

RDP T-connection*/**

○ White



NEW
IN BLACK
20mm

Model	RDP20-T	RDP25-T	RDP32-T
Part Nr	0513.00005.022	0513.00105.022	0513.00205.022
Colour	white	white	white
Packing	160 pcs (8 x 20)	100 pcs (5 x 20)	60 pcs (3 x 20)
PALLET	5120 pcs (32 BOX)	3200 pcs (32 BOX)	1920 pcs (32 BOX)

RDP Extension*/**

○ White



NEW
IN BLACK
20mm

Model	RDP20-XT	RDP25-XT	RDP32-XT
part Nr	0513.00006.022	0513.00106.022	0513.00206.022
Colour	white	white	white
Packing	240 pcs (12 x 20)	200 pcs (10 x 20)	100 pcs (5 x 20)
PALLET	7680 pcs (32 BOX)	6400 pcs (32 BOX)	3200 pcs (32 BOX)

Reducer*/**

○ White



NEW
IN BLACK
20mm

Model	RDP25-20 RD	RDP32-25 RD
part Nr	0513.00107.022	0513.00207.022
Colour	white	white
Packing	200 pcs (10 x 20)	100 pcs (5 x 20)
PALLET	12800 pcs (64 BOX)	6400 pcs (64 BOX)

RDP-Clip

○ White

> For wall and ceiling



NEW
IN BLACK
20mm

Model	RDP20-CLIP	RDP25-CLIP	RDP32-CLIP
Part Nr	0513.00004.022	0513.00104.022	0513.00204.022
Colour	white	white	white
Packing	500 pcs (25 x 20)	500 pcs (25 x 20)	500 pcs (25 x 20)
PALLET	32000 (64 BOX)	32000 (64 BOX)	24000 (48 BOX)

Transparent Sifon**

NEW

○ Transparent

- > Avoids bad smells!
- > Can only be installed vertically
- > Transparent for an easy inspection

Model	RDP-SIF-V
Part Nr	0514.00008.022
Colour	Transparent
A = Internal Ø	for 16 / 18 / 20 mm
B = External Ø	for 16 / 18 / 20 mm
Packing	20 PC
Pallet	960 pcs (48 BOX)



Tray Outlet Connection**

○ White

- > For a professional connection to a drain pan

Model	TO25
Part Nr	0513.00544.000
Colour	white
Connection Ø	20mm
Packing	100 x 1 pc
Pallet	6400 pcs (64 BOX)

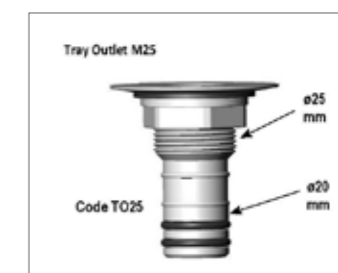

* Pre-mounted and pre-lubricated O-rings : CHAMFER and DEBURR the pipe before inserting it in fittings to avoid damage to the O-rings !
** To be used only for the outlet of air conditioning condensation water (without pressure)

* Pre-mounted and pre-lubricated O-rings : CHAMFER and DEBURR the pipe before inserting it in fittings to avoid damage to the O-rings !
** To be used only for the outlet of air conditioning condensation water (without pressure)

RDP Sifon*/**

○ White

- > Avoids bad smells!
- > Can be installed vertically and horizontally
- > Various connection combinations possible. Contact us
- > Inspectable



Maintenance & Inspection

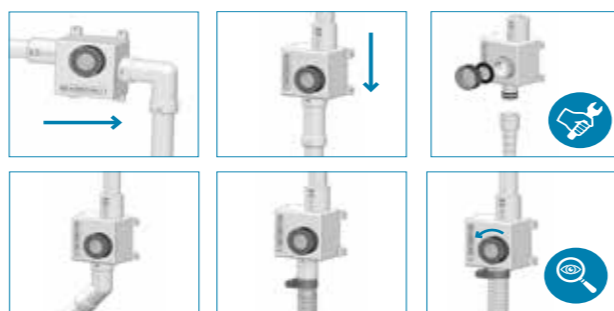
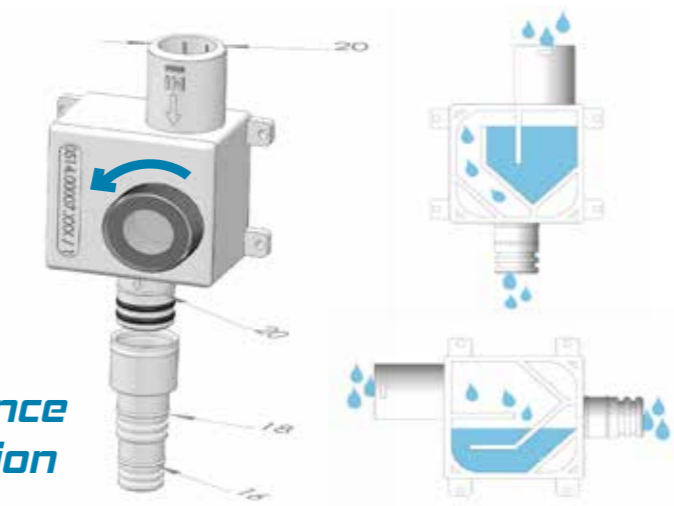
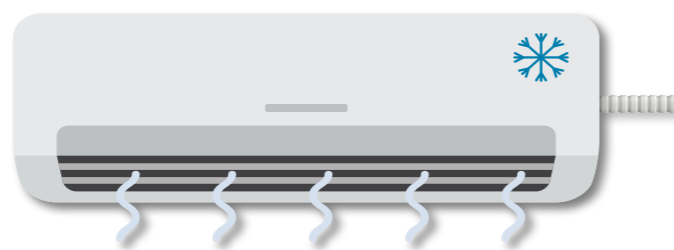

Model	RDP.SIF-OHV
Part Nr	0514.00007.022
Colour	white
A = Ø	20mm
B = Internal Ø	16 - 18mm
Packing	20 x 1 PC
Pallet	1280 pcs (64 x 20)

Transparent 6-9 Drain Hose**

○ Transparent

- > Connects to condensate water removal pumps

Model	A.DPT.95
Part Nr	0511.00201.033
Colour	Transparent
External Ø	9mm
Internal Ø	6mm
Packing	50M (ROLL)
Pallet	5000M (100 ROLL)



Condensation hose Connection Soft-Rigid (CCSR)**

- > We recommend the use of hose clamps (not supplied) to ensure watertightness

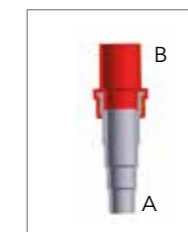

Model	CCSR.16	CCSR.18	CCSR.20	CCSR.25	CCSR.32
Part Nr	0514.00001.022	0514.00002.022	0514.00003.022	0514.00004.022	0514.00005.022
A = External Ø	14 / 16 / 18 / 20 mm	14 / 16 / 18 / 20 mm	14 / 16 / 18 / 20 mm	14 / 16 / 18 / 20 mm	14 / 16 / 18 / 20 mm
B = Internal Ø	16 mm	18 mm	20 mm	25 mm	32 mm
Colour (soft part)	Yellow	Red	Blue	Green	Grey
Packing (small)	20 pcs	20 pcs	20 pcs	20 pcs	20 pcs
Packing	300 pcs (15x20 pcs)	300 pcs (15x20 pcs)	300 pcs (15x20 pcs)	300 pcs (15x20 pcs)	300 pcs (15x20 pcs)
Pallet	9600 pcs (32 BOX)	9600 pcs (32 BOX)	9600 pcs (32 BOX)	9600 pcs (32 BOX)	9600 pcs (32 BOX)



* Pre-mounted and pre-lubricated O-rings : CHAMFER and DEBURR the pipe before inserting it in fittings to avoid damage to the O-rings !
 ** To be used only for the outlet of air conditioning condensation water (without pressure)

** To be used only for the outlet of air conditioning condensation water (without pressure). CHAMFER and DEBURR the pipe before inserting it in CCSR fittings to avoid damage

Corrugated Drain Hose**



White

- > For the removal of air conditioning condensation water
- > Connects to Ø 16, 18 and 20mm systems
- > With regular cut marks
- > 50 M hose in a carton box



Model	A.DP.96
Part Nr	0511.00301.033
Colour	white
Connections	16 - 18 - 20 mm
Packing	50 M (BOX)
Pallet	4500 M (90 BOX)

Condensation Connect Y**



White

- > Connects to A.DP.96 drain hoses



Model	CCY
Part Nr	0511.00003.022
Top connections Ø	2 x 20mm
Bottom connections Ø	1 x 18mm
Packing	200 pcs
Pallet	9600 pcs (48 BOX)

Spiral Drain Hose **



White

- > For the removal of air conditioning condensation water
- > Smooth Inside



Model	A.DPS.16	A.DPS.20
Part Nr	0511.00101.034	0511.00102.034
Connects to	16mm	20mm
Packing	30 M (ROLL)	30 M (ROLL)
Pallet	4320 M (144 ROLLS)	3360 M (112 ROLLS)

Condensation Connect Y Smooth**

- > Connects to A.DPS Drain Hoses



Model	CCSY
Part Nr	0511.00103.022
Connections	16 - 18 - 20 mm
Packing	100 pcs (5 x 20)
Pallet	3200 pcs (32 BOX)

** To be used only for the outlet of air conditioning condensation water (without pressure)

Pre-installation Boxes with Vertical Outlet**



White

- > Built-in box for pre-installation of air-conditioning systems
- > Connections for Ø 16, 18 and 20 mm drain pipes and hoses

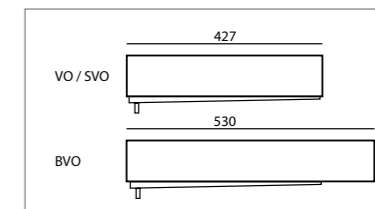
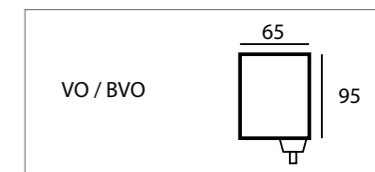

Model	E-BOX VO-L	E-BOX BVO-L
Part Nr	0510.00101.022	0510.00103.022
Colour	white	white
Dimensions (mm)	427 x 95 x 65mm	530 x 95 x 65mm
Dimensions (inch)	16,81 x 3,74 x 2,56"	20,87 x 3,74 x 2,56"
Packing	25 x 1 PC	20 x 1 PC
Pallet	500 PCS (20 BOX)	400 PCS (20 BOX)

Pre-installation Boxes with Horizontal Outlet**



White

- > Built-in box for pre-installation of air-conditioning systems
- > Connections for Ø 16, 18 and 20 mm drain pipes and hoses

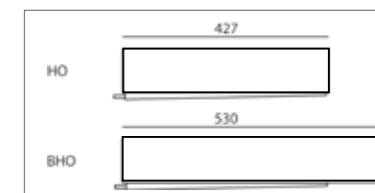
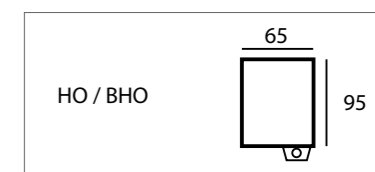

Model	E-BOX HO-L	E-BOX BHO-L
Part Nr	0510.00001.022	0510.00003.022
Colour	white	white
Dimensions (mm)	427 x 95 x 65mm	530 x 95 x 65mm
Dimensions (inch)	16,81 x 3,74 x 2,56"	20,87 x 3,74 x 2,56"
Packing	20 x 1 PC	20 x 1 PC
Pallet	400 PCS (20 BOX)	400 PCS (20 BOX)

** To be used only for the outlet of air conditioning condensation water (without pressure)

Condensation Trays

○ White

- > Tray for the collection of condensation water
- > Made from rigid UV-stabilized plastics (no rust)
- > Adjustable arm fixation
- > Moulded water outlet for Ø 16 mm, 18 mm and 20 mm.
- > Connects to standard drain pipes and drain hoses

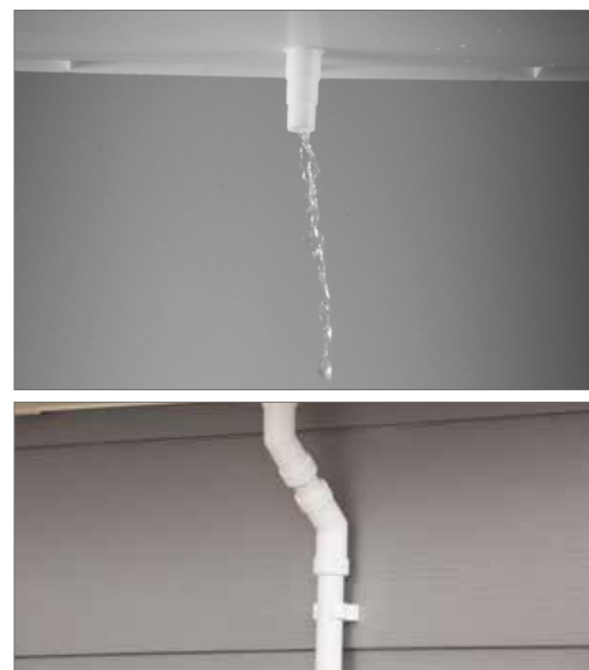
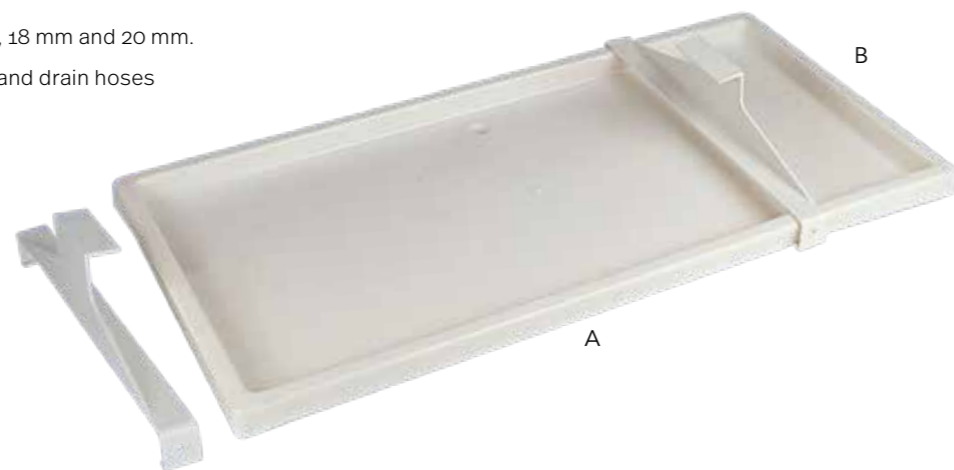

Model	TCCW-79-IND	TCCW-94-IND
Part Nr	0509.00001.032	0509.00002.031
Colour	white	white
Length (A)	790mm (31,10")	940mm (37,01")
Width (B)	390mm (15,35")	420mm (16,54")
Packing	1 PC	1 PC
Pallet	75 pcs	70 pcs



AIR CONDITIONING LINE SET BENDER



ONLY FOR
SOFT COPPER!

EASY
TO USE!

REUSABLE
IF CLEAN!

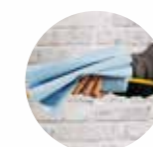
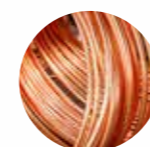

12 mm for 5/8" 9 mm for 1/2" 6 mm for 3/8" 4 mm for 1/4"

NEW
ADD-ON for 3/4"

16 mm

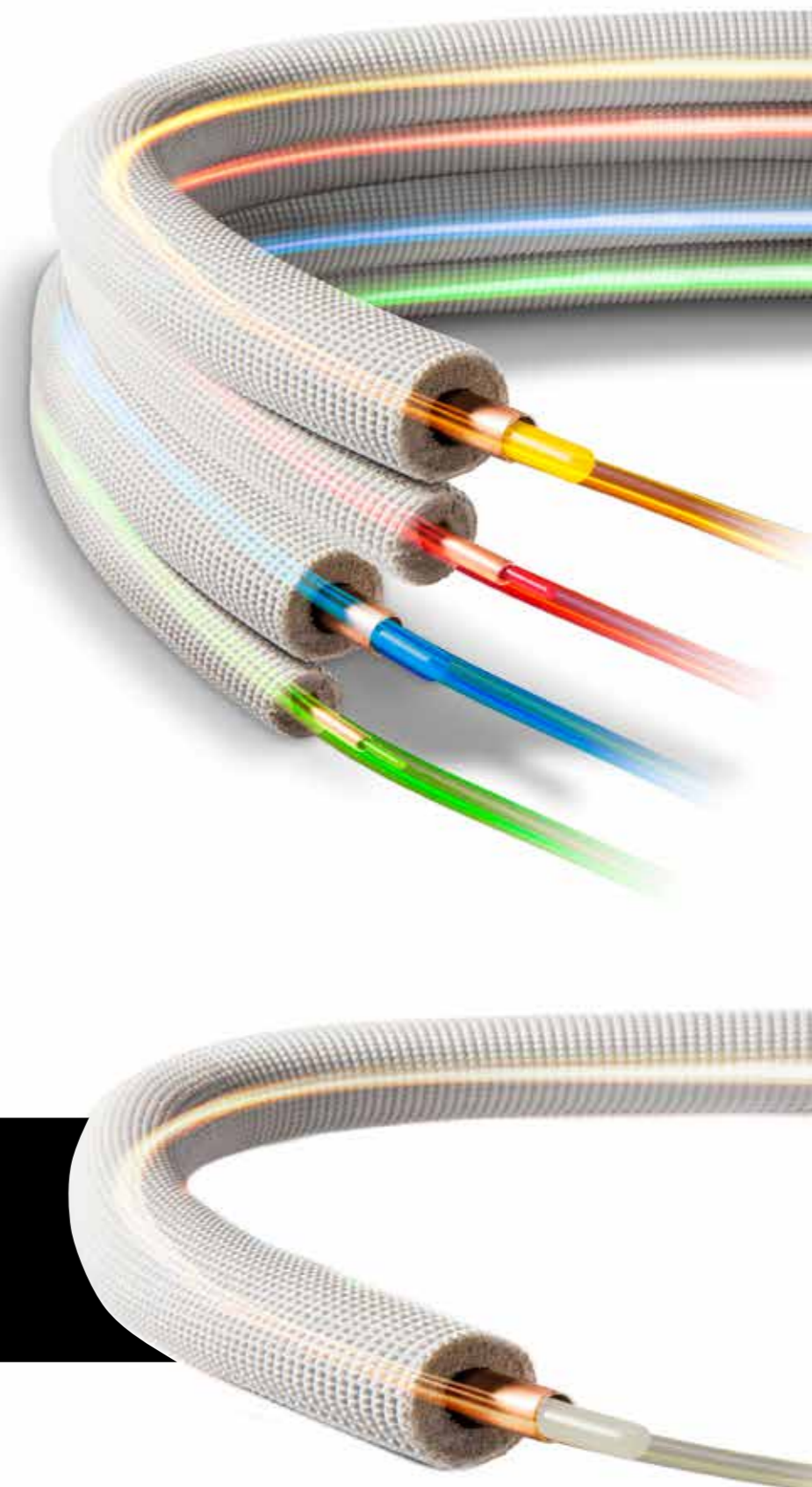

FrameFoot®

Adjustable height

Easy to install

Equipped with plastic foot
and anti vibration rubber mat

Galvanized steel

Personalized projects
on request

supporting system
for heavy-duty units

FrameFoot® Heavy Duty

- > Heavy Duty supporting system for external units
- > Modular and Extendable

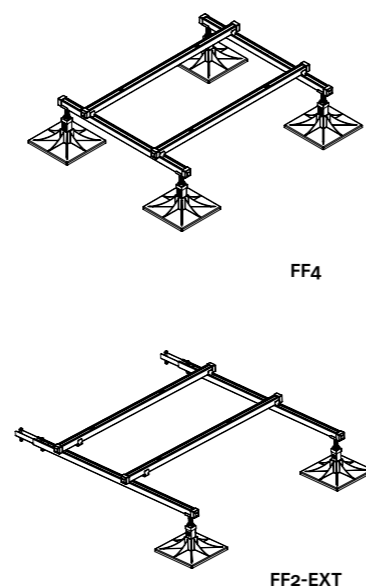

Model	FF4	FF2-EXT
Part Nr	0502.00027.004	0502.00027.002
Max spread load capacity	500 kg / M ²	500 kg / M ²
Packing	1 SET	1 SET

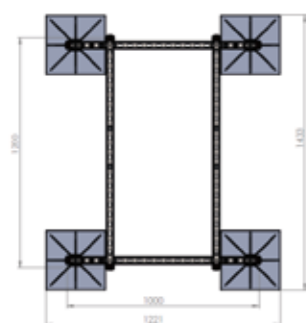

FF4

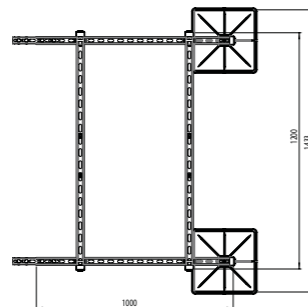

FF2-EXT

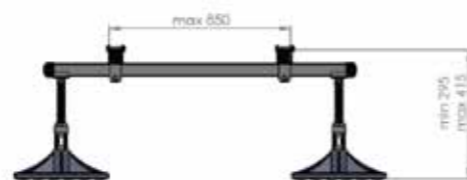

FF4

Other FrameFoot® configurations or solutions can be available on request. Contact us

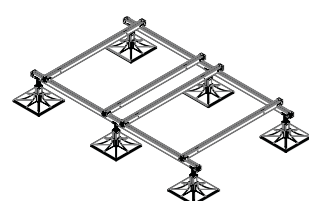

FF6

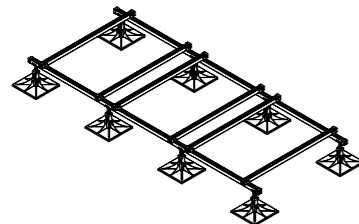

FF8

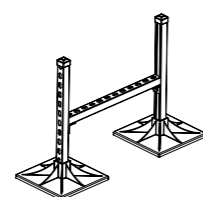

HF-600

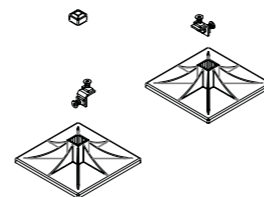

HF-DIY.01

Copyright © 2022 Castel Engineering srl - CAT.AIRCO22v1-1X-F00.000000.020

Copyright © 2022 Castel Engineering srl - CAT.AIRCO22v1-1X-F00.000000.020

FrameFoot® Mini

NEW

- > Compact anti-vibration stand
- > Fits particularly well heat pumps
- > Comes complete in 1 single box



HEAT PUMP SPECIAL

Model	FF-755	FF-1250 Mono	FF-1250-VR
Part Nr	0502.00030.000	0502.00030.001	0502.00030.002
Max spread load capacity	360 kg	450 kg	450 kg
Colour	Black grey (7021)	Black grey (7021)	Black grey (7021)
Max unit Width (W) x Depth (D)	755 (29,72") x 520mm (20,47")	1250 (49,21") x 520mm (20,47")	1250 (49,21") x 820mm (32,28")
Min unit Width (W) x Depth (D)	450 (17,72") x 120mm (4,72")	690 (27,16") x 120mm (4,72")	690 (27,16") x 120mm (4,72")
Min - Max height	330 - 370mm (12,99" x 14,57")	330 - 370mm (12,99" x 14,57")	330 - 370mm (12,99" x 14,57")
Inclination (roof)	min. 0° - max. 5°	min. 0° - max. 5°	min. 0° - max. 5°
Packing	1 BOX	1 BOX	1 BOX
Pallet	40 BOX	40 BOX	30 BOX

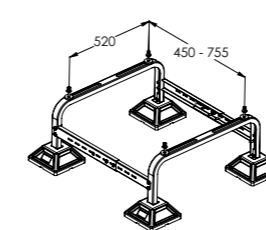

FF-755

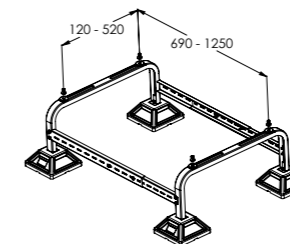

FF-1250 Mono

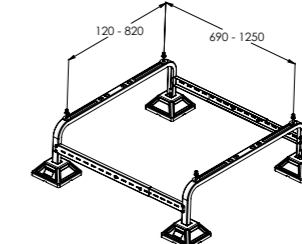

FF-1250 VR

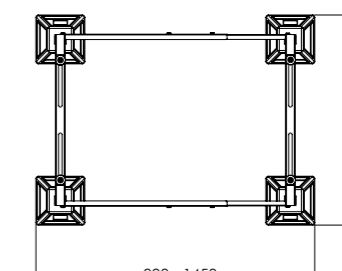
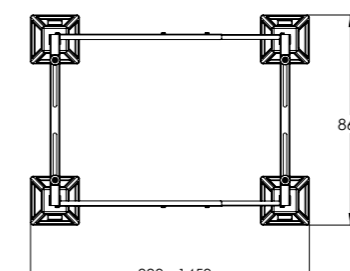
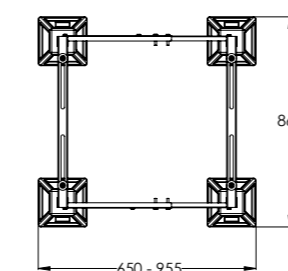
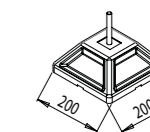
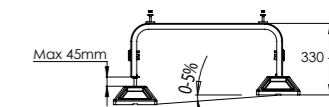

CONTACT US
FOR



by Castel Engineering

HYGIENIC ACCESSORIES
AND CEILING SUSPENSIONS
FOR AGRO-ALIMENTARY,
COLD- AND CLEANROOM
INDUSTRIES

COVINGS

BACKING PROFILES

PLINTHS

SUSPENSIONS



ENGINEERED QUALITY PRODUCTS
FROM THE ORIGINAL MANUFACTURER SINCE 1987

www.castel-engineering.com



New Storage Building at Head Quarters in Belgium

Castel Engineering srl (H.Q.)
Rue de la Royenne 84
7700 Mouscron - Belgium
T. +32 56 33 68 40
info@castel-engineering.com
castel-engineering.com

Castel Engineering Polska Sp. z o.o.
Tomaszowice Kolonia 126
21-002 Tomaszowice - Poland
T. + 48 81 503 28 22
biuro@castel-engineering.com
castel-engineering.com

Rodigas Srl
Via Giacomelli, 10,
35010 Limena (Padova) - Italy
Tel. +39 049 884 00 56
Email. info@rodigas.it
www.rodigas.it/en